

A-A

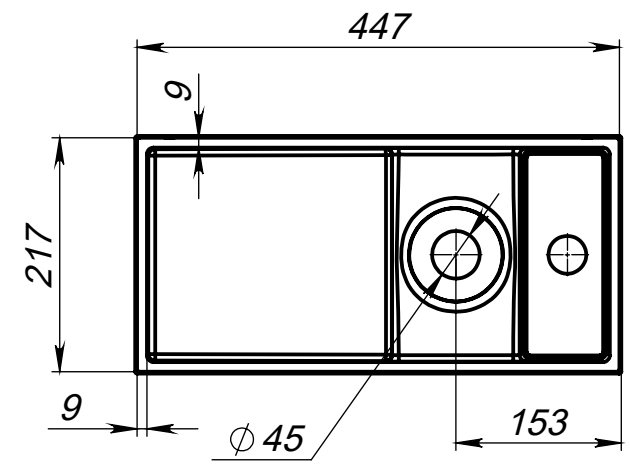

B-B

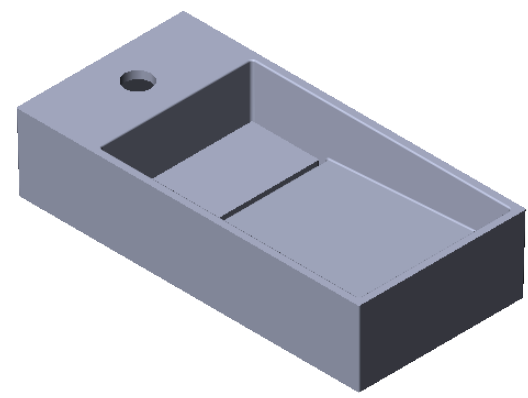
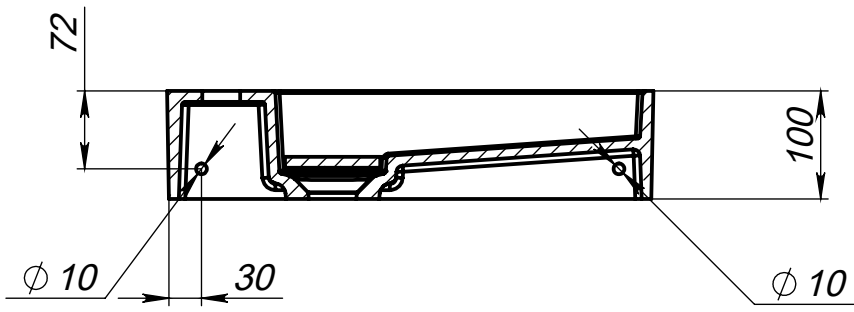

Length tolerance	+3/-3 mm	Design engineer	Date of project	Length tolerance (mm)	+3/-3 mm	Scale	1:10
Width tolerance	+1,5/-1,5mm	Project ID	01.150	Name	Toni 450 R		
Tap hole positional tolerance	+3/-3 mm	<h1>Miraggio</h1>		Art. N°	450/220		
Overflow positional tolerance	+3/-3 mm			Dimensions	450/220		
Highth tolerance	+2/-2 mm	Weight tolerance	±3%	Weight	6.3 kg		